

RKD & BRK Modules for VCV Rack

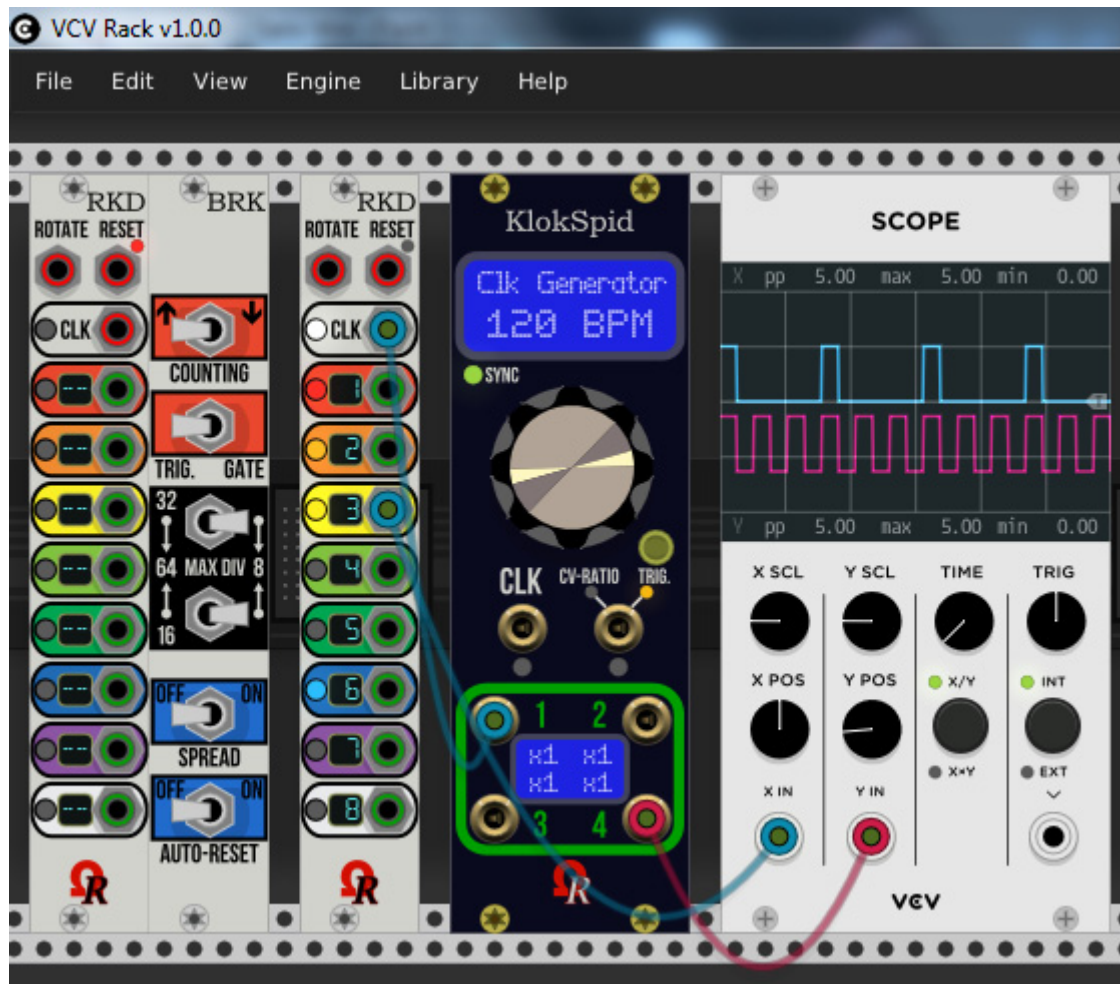

User's Manual

(c) 2019 Dominique CAMUS (Ohmer Modules)



INTRODUCTION

RKD (stands for **Rotate Klok Divider**) is basically a clock divider module, having 8 output jacks, each of them have its divided clock ratio (and all are always different at a given time). Dividers (clock ratios) are based on built-in tables such manufacturer table, or one of four "extra" tables (described later).

One of amazing feature supported by RKD module is **table rotations**. Table rotations are controlled by external voltage (CV), applied to **ROTATE** input jack. Of course, this feature will be explained, later.

RKD looks as 4 HP module (1 in./20.32mm width), it can easily enter in any rack, but its major disadvantage is the way to configure it (custom setting), due by six "jumpers" (kind of small electrical shunts located on module's PCB - printed circuit board) like real hardware!

Fortunately, **BRK**, also a 4 HP module, when placed alongside right or left (without sapce) of RKD, module permits a more comfortable access to module's setting without need to access to jumpers, by offering six equivalent switches mounted on separate panel. When the RKD settings was finished, you have the choice to keep BRK in your rack, or... to remove it!

MODULE LAYOUT (RKD)

RKD signal workflow is mainly from top to bottom. This module have three input jacks, located near top: **ROTATE** and **RESET**, then **CLK**. Any input jack uses a red ring. All other eight jacks (numbered "1+R", "2+R", "3+R"... to "8+R") are outputs (they use green rings).

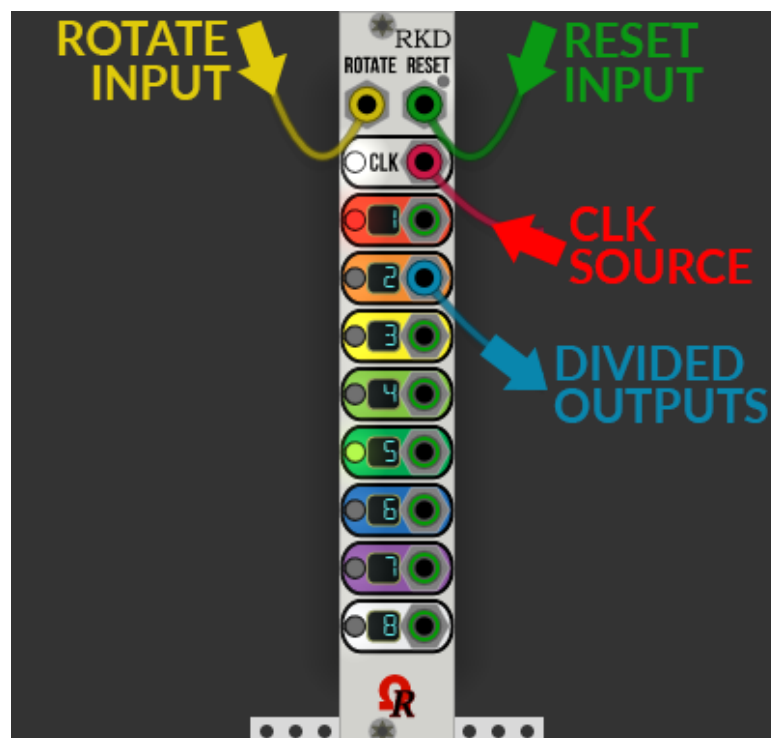

Also, RKD module provides useful indicators, like:

- A tiny "tri-colored" LED near RESET jack (each LED color will be explained later).
- White rounded LED, alongside CLK input jack, blinking on incoming clock pulses.
- Eight colored round LEDs, alongside 1+R, 2+R, 3+R, 4+R, ... 7+R, and 8+R output jacks.
- Two-digit (cyan) segment-LED display, belong each output jack.

MODULE LAYOUT (BRK EXPANDER PANEL)

Typically a *companion* panel for RKD module, that hosting **six mechanical switches**:

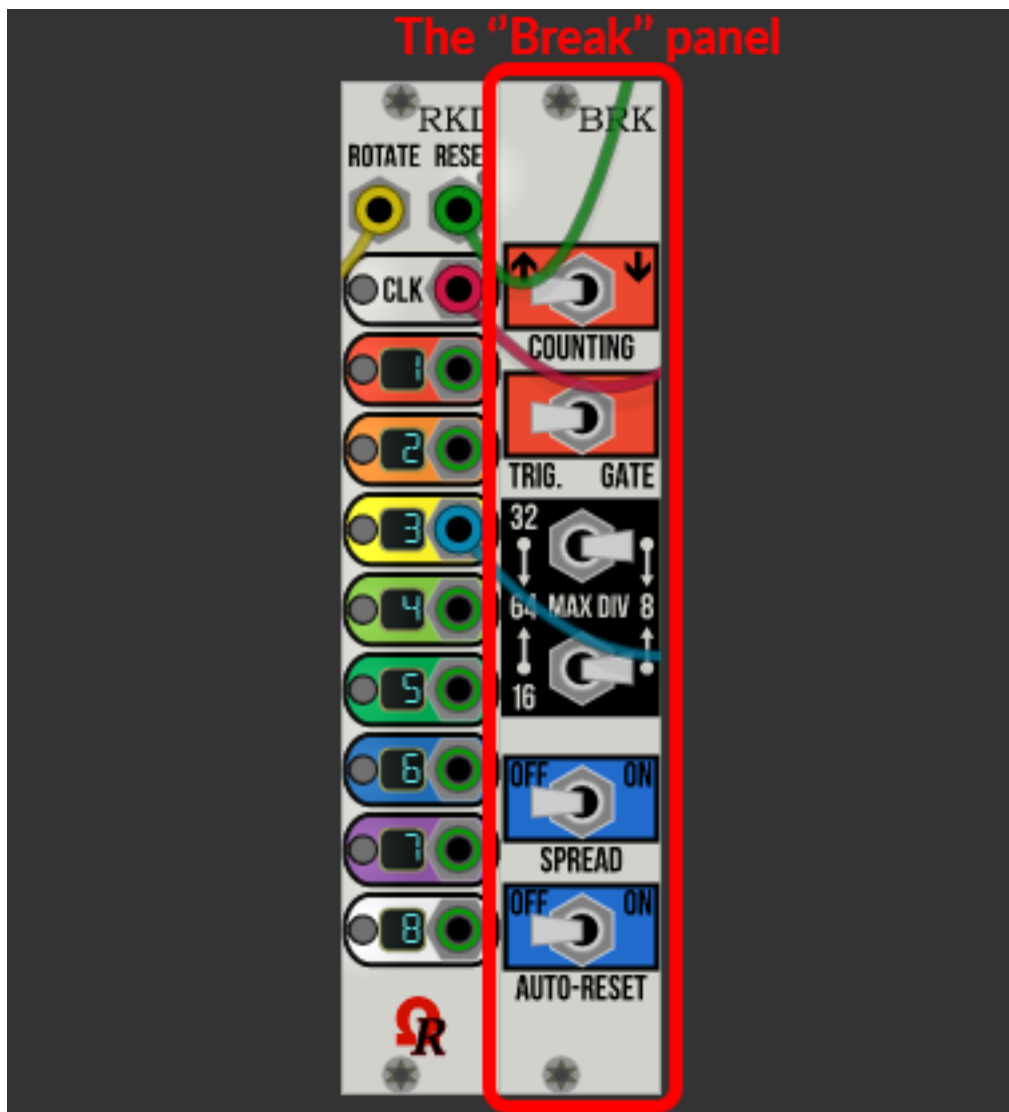

Please notice the BRK module doesn't embed indicators nor electronic components, but six mechanical switches only. Also BRK doesn't need power source (like any passive panel), but it must be placed at right or left side of RKD module you'll want to set-up (without space between them).

KEY FEATURES

- Support source clock (CLK) signal. Trigger @+3.5V (rising edges), any waveform.
- 8 output jacks, CLK-divided from 1 upto 64, trigger (default) or gate outputs (+5V).
- Up-beat (default) or down-beat counting mode (for both trigger / gate mode).
- Segment-LED displays, near each output jack, displaying current dividers (in real-time).
- ROTATE input jack (0V ~ +5V CV-based) to "rotate" dividers along all output jacks.
- 5 dividers tables (can be chosen via context-menu). "Manufacturer" is always default.
- Optional "spread" dividers (only applicable for "Manufacturer" dividers table).
- Buffered RESET input jack (trigger @+3.5V on rising edge, retrigger @+0.2V on falling edge).
- Optional "Auto-Reset" feature, useful to re-synchronize "weird" dividers to current tempo.

BASIC USAGE OR... HOW TO DIVE INTO "RKD" WORLD!

Like static clock modulator devices, RKD module is ready to use (as-is) when added in your rack. Each output jack provides different dividers, so this will offer many choices.

This is an example of basic module usage (untouched default setting, not patched CV):

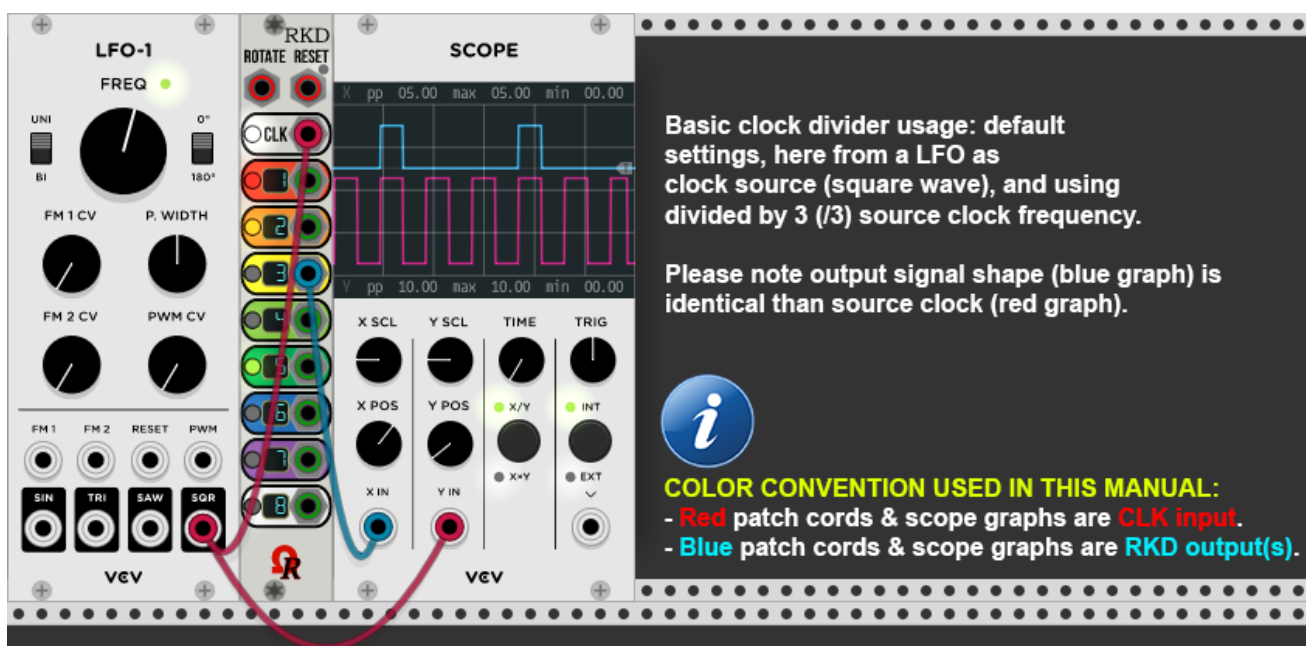

Another tip: if case your rack needs a "native" divider (as default/base, without CV usage), perhaps you'll can find it, by trying different built dividers tables, via context-menu (right mouse click over RKD module).

For example, your rack needs **/64** to reset/re-sync many sequencers. Fortunately, you're a lucky guy, because you'll can find this divider from both **Perfect squares** or **Triplet & 16ths** dividers tables. Then, by patching **"8+R" output jack** to your slave sequencers... Easy, aren't?

Of course, you was lucky to have got a native divider, quickly! Sometimes, it will may more difficult in case you'll need rare, or "weird" (exotic) divider, such $/29$, $/37$, $/53$... but...

...ROTATE jack is your buddy! by applying a **static voltage** on ROTATE jack (from 0V to +5V, by voltage thresholds), this will change all dividers on every output jack:

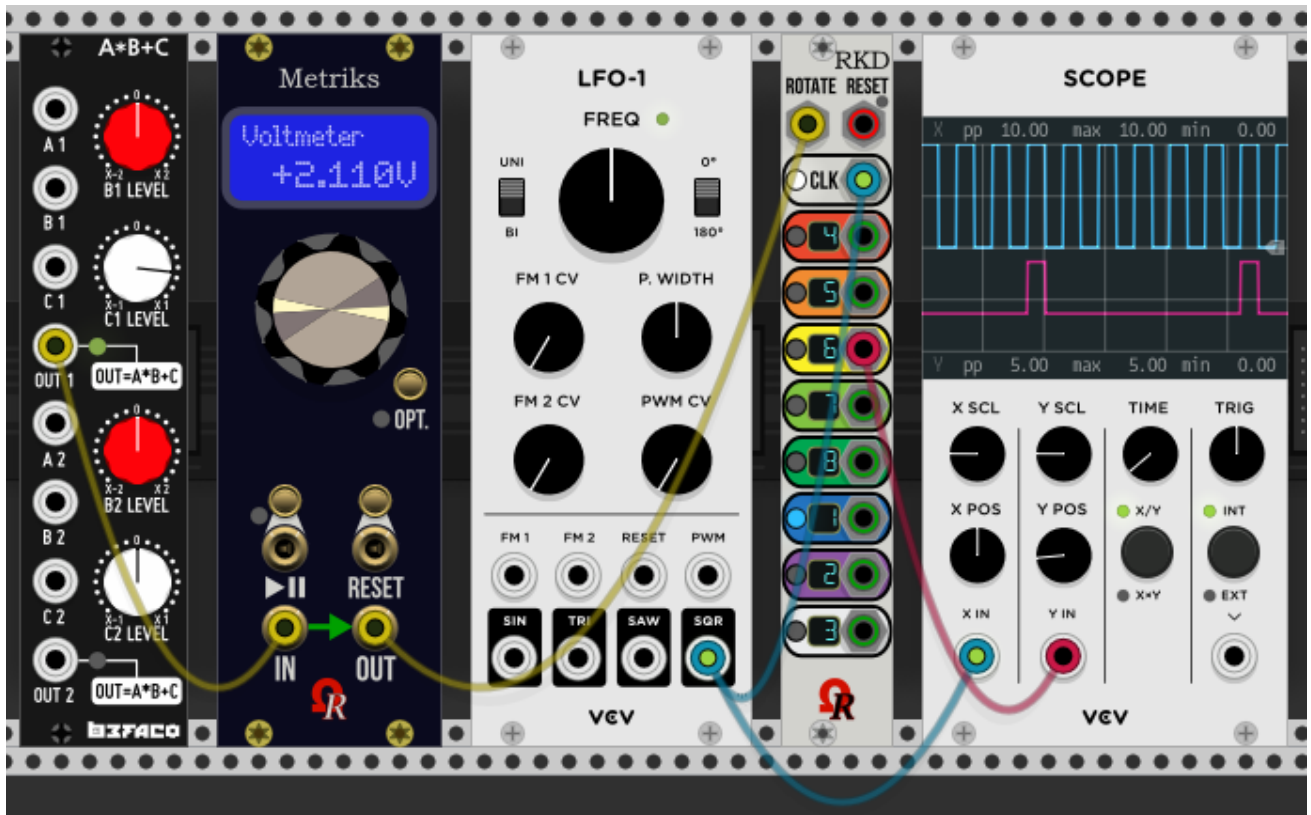

Example above uses constant **+2.11V** control voltage, applied on ROTATE jack (yellow patch cord) by Befaco's **A*B+C** module, and confirmed by **Voltmeter** (Metriks module).

You'll can notice all dividers have been changed, as indicated by their segment-LED displays, so the previously used "3+R" output jack have "moved" from $/3$ to... $/6$. Bingo!

This behavior is called **TABLE ROTATION**, or more usualy: **ROTATION**.



Valid CV range for ROTATE jack is 0V to +5V.
Negative voltage (or disconnected) is assumed as 0V by RKD module firmware.
Also, voltages over +5V are always assumed equal to +5V (hard clipping).

Obviously, it's a simple situation, because the control voltage applied on ROTATE input jack, is static. By this way, all dividers for output jacks remain unchanged while this CV is held.



It's an easy trick to use any custom clock divider you'll want in your rack!

Instead of to use a "static" voltage on ROTATE jack (static dividers on RKD), you'll can use dynamic voltages, instead, generated from CV-based sequencer, oscillator, LFO, envelope generator, random noise, S&H, sample, or any source voltage you'll want, in fact, the unique condition is to keep voltage into 0V / max. +5V range.

RKD module becomes a powerful weapon for your rack and for... creativity!

About table rotation, you'll can find details about dividers tables, and their possible rotations, later in this manual.

Obviously, you'll can combine many RKD modules together, by chaining them, one output jack patched to CLK jack on another, create loops... In fact... depending your needs!

Common strange behavior have been reported by some users, on social networks:
The infamous "-- --" signs on all jack displays. Why?

i RKD module requires a source clock to operate, patched on its CLK input jack. In case the CLK jack isn't connected, all dividers displays are showing "-- --", and small LED near RESET jack is lit (red color), indicating error condition:



RESET LED behaviors will be detailed later in a specific chapter.

(INTENTIONALLY BLANK SPACE, DUE TO PAGE LAYOUT)

JUMPERS

By using the real Eurorack hardware equivalent, you'll must remove the RKD module away from rack in order to access to six jumpers (shunts), located on module's PCB (printed circuit board). Obviously, from VCV Rack, don't remove the RKD module away from your rack!

Instead, do a right-mouse button click over RKD module you'll want configure, then select **Access jumpers (located on PCB)** at the bottom of context-menu. Now, the module becomes "nude like a worm" and you can discover, at the bottom of module, a group of six blue shunts, named **jumpers**.

To change jumper position, simply click on it (left-mouse). Each jumper acts as On/Off (toggle) switch. Certain setting needs the jumper is installed (On = up position), or removed (Off = down position). Each jumpers is named **J1** to **J6**, from left to right:

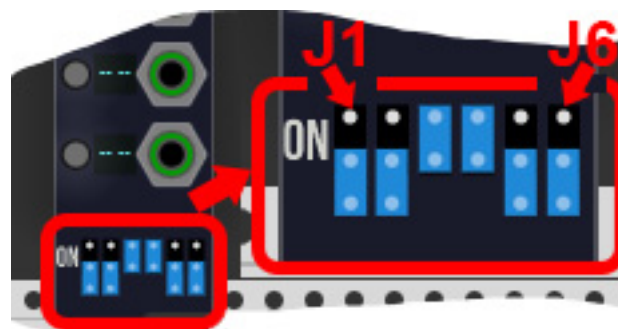

Jumper	Feature	Position	Behavior description
J1	Counting	ON	Down-beat counting.
		OFF	Up-beat counting (default).
J2	Trig. / Gate	ON	All jacks output gates.
		OFF	All jacks output triggers (default).
J3	Max Div 16	ON	Max. divider may be 8 (J4=On) or 16 (J4=Off).
		OFF	Max. divider may be 8 (J4=On) or 64 (J4=Off).
J4	Max Div 32	ON	Max. divider may be 8 (J3=On) or 32 (J3=Off).
		OFF	Max. divider may be 8 (J3=On) or 64 (J3=Off).
J5	Spread	ON	Spread on (applicable on manufacturer table only).
		OFF	Spread off/disabled (default).
J6	Auto-Reset	ON	Auto-Reset fired every "Max Div" x 2 clocks.
		OFF	Auto-Reset off/disabled (default).

Jumpers J3 & J4 are working together, offering four maximum divider (Max Div) possibilities. These jumpers (and switches equivalent on BRK panel) are used only for "Manufacturer" dividers table (ignored for extra tables like "Primes numbers", "Fibonacci sequence", etc.)

UP-BEAT VS. DOWN-BEAT COUNTING

Default (factory), **counting** is set to **up-beat counting**, but can be changed to **down-beat counting**, instead, either by installing (On) **J1 jumper** (RKD module), or by changing **COUNTING switch** to right position, from BRK panel (position indicated by "down arrow"):

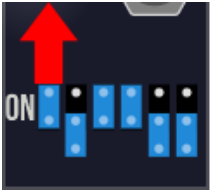

Setting for down-beat counting.

For the following explanations, **N** stands for current **DIVIDER** used by (specific) output jack. Also, **C** may be used to indicate pulse **COUNTER** (number of **CLK**).

UP-BEAT COUNTING

Relevant output jack will start to fire (from the first time) after **N** counted clock pulses ($C=N$). Then, it will continue to fire on every **C** incoming **CLK** pulses...

Incoming CLK pulses (outputs are always fired on CLK rising edges)																																				
Divider (N)	1	2	3	4	5	6	7	8	9	10	11	12	13	14	15	16	17	18	19	20	21	22	23	24	25	26	27	28	29	30	31	32				
/1	X	X	X	X	X	X	X	X	X	X	X	X	X	X	X	X	X	X	X	X	X	X	X	X	X	X	X	X	X	X	X	X				
/2		X		X		X		X		X		X		X		X		X		X		X		X		X		X		X		X				
/3			X			X			X			X			X			X			X			X			X			X			X			
/4				X				X				X				X				X				X				X				X				
/5					X					X					X					X					X					X				X		
/6						X					X					X					X					X					X				X	
/7							X					X					X					X					X					X				X
/8								X						X						X						X						X				X

Up-beat counting table (each "x" represent a firing output jack).

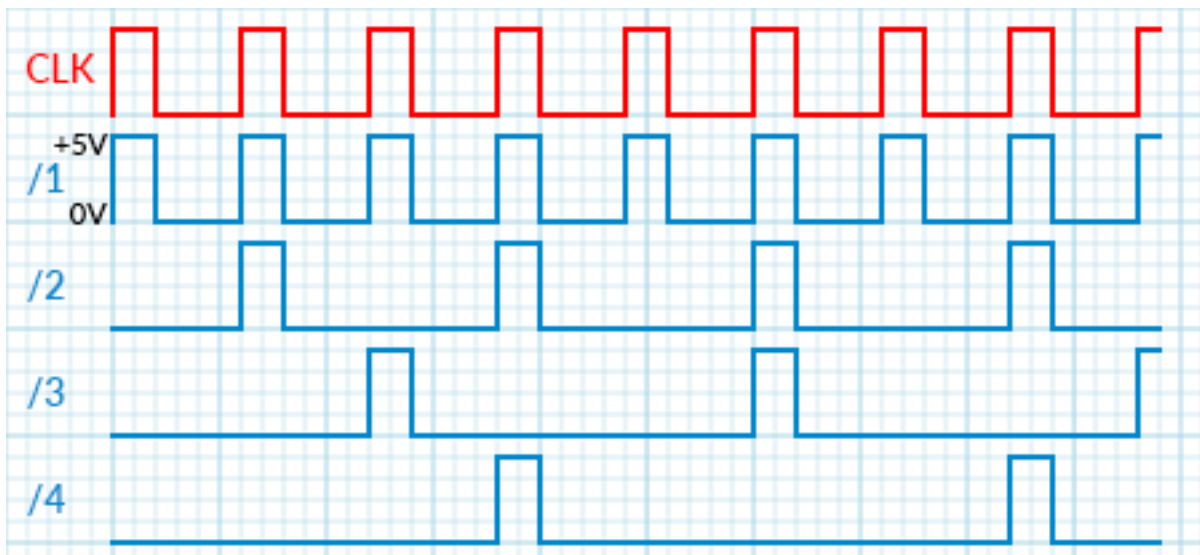

Up-beat counting for source clock (CLK 33%) and outputs from /1 to /4 (triggers).

TRIGGER VS. GATE

RKD module is able to output triggers or gates. Previously, in up-beat and down-beat counting explanations, both graphs show triggers.

Default (factory) is always set to **trigger**, but can be changed to **gate**, instead, either by installing (On) **J2 jumper** (RKD module), or by changing **TRIG. GATE switch** to right position, from BRK expander panel ("GATE" position):

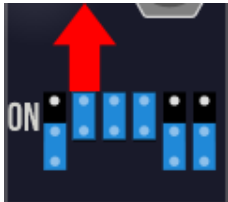

Setting for gate mode (instead default "trigger").

Depending you needs, you'll use triggers for short-duration pulses, for example to control basically a sequencer, to trigger a drumkit, a Bernoulli gate, a clock modulator (including another RKD module) or any "trigger & forget"-based modules.

Instead, other situations may require a sustained (held) voltage during a certain time). The most common usage is to control the sustain (S) stage of ADSR envelope generator, reverb tail, delays. Held voltages during a "longer" time are designed as "gates".

TRIGGER

When RKD module is set as "trigger" (TRIG.), any output always have exactly the same waveform than souce clock (like illustrated by graphs, pages 8 and 9, and below).

Any output is always fired (+5V) on incoming clock pulse (+3.5V or more, as "trigger voltage" received on its CLK input jack). Incoming clock pulse events are named... **rising edges**.

Fired outputs are held at +5V, until source clock voltage falls under +0.2V. These events, when source voltage is falling, are named... **falling edges**. Easy, aren't?

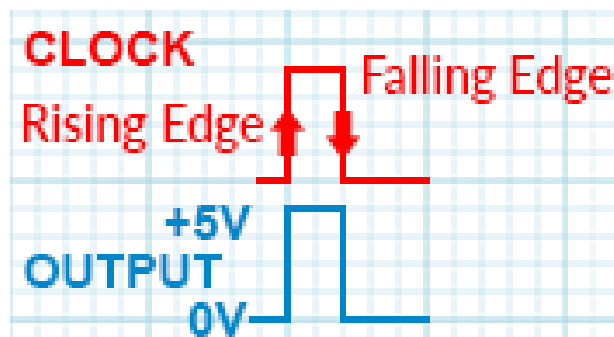

GATE

Gate concepts proposed by RKD module is a bit difficult to explain, but not too difficult to understand, because they're many possible scenarios!

Firsly, concerning /1 output jack, they're no difference between trigger and gate!
/1 output jack always follows source **CLK** waveform.

Principle of gates is based on "output state inversion" (like an on/off switch does):

- from 0V to +5V (output rising edge), when output state is low (0V).
- from +5V to 0V (output falling edge), when output state is high (+5V).

Like trigger does (as described in previous pages), gate can be combined together with up-beat or down-beat counting, as you want.

The following graph shows how gates are triggered (and sustained) when the source CLK is a square wave (50%), **up-beat counting** (factory), from /1 to /4 output jacks:

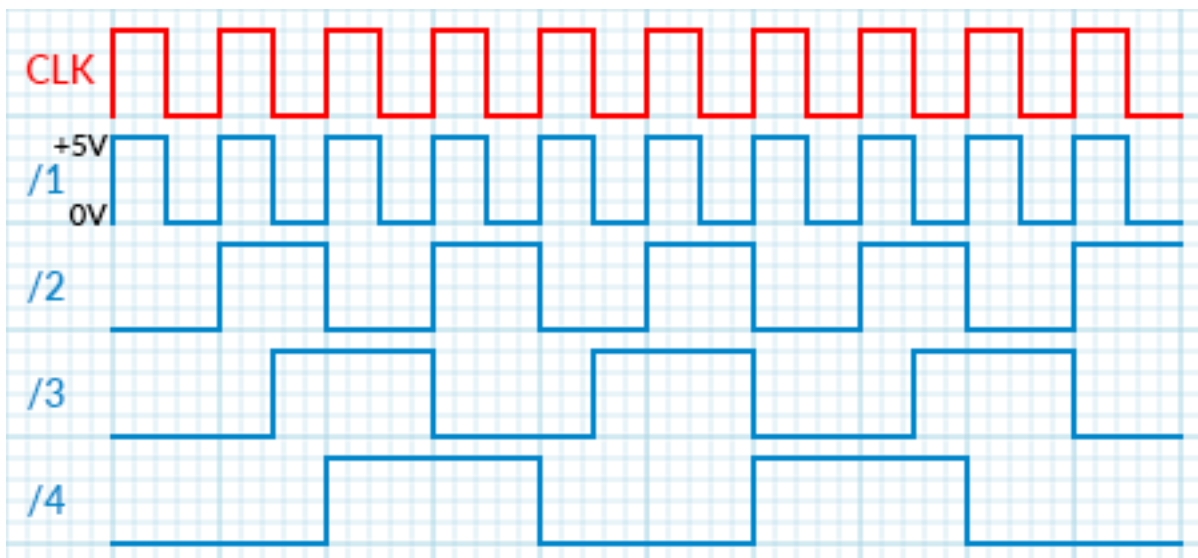

Up-beat counting for square source clock (CLK 50%) and outputs from /1 to /4 (gates).

You'll can observe, for /3, the output state changes once on CLK falling edge, then once on CLK rising edge, alternatively. **This technique is called "2.5"**.

This rule is true for any odd divider. Also valid for /1, as... odd divider.

By the same way, for even dividers, you'll can see all state changes are always done during CLK rising edge only.

The following graph shows how gates are triggered (and sustained) when the source CLK is a square wave (50%), but **up-beat counting**, from /1 to /4 output jacks:

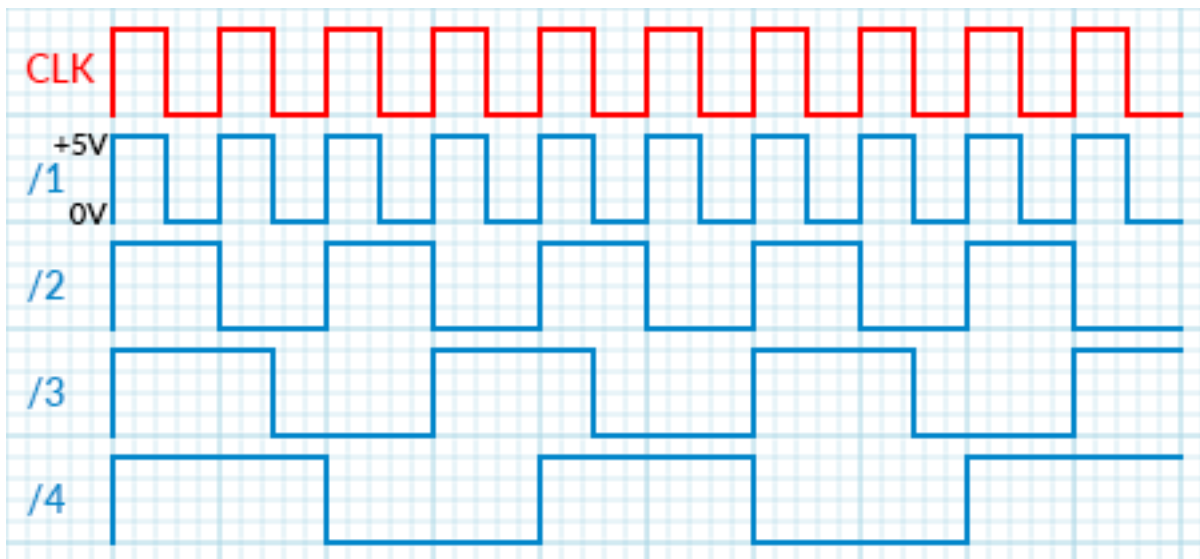

Down-beat counting for square source clock (CLK 50%) and outputs from /1 to /4 (gates).

Except for output /1, as usual (remember output /1 is always a replicated CLK signal, unaltered, in all circumstances), in down-beat counting, all gates are... inverted!

Okay, but for previous "gate" scenarios (up-beat and down-beat counting), we were living into an ideal world, I mean... by using a square (50%) waveform source clock. But some third-party clock generator modules don't offer a square (however, KlokSpid module, from Ohmer Modules, can output either fixed-duration pulses or many gate-based patterns).

Following graph shows how gates are triggered (and sustained) when the source CLK is 33% (1/3 high-state, 2/3 low-state), **up-beat counting** (factory) again, from /1 to /4 output jacks:

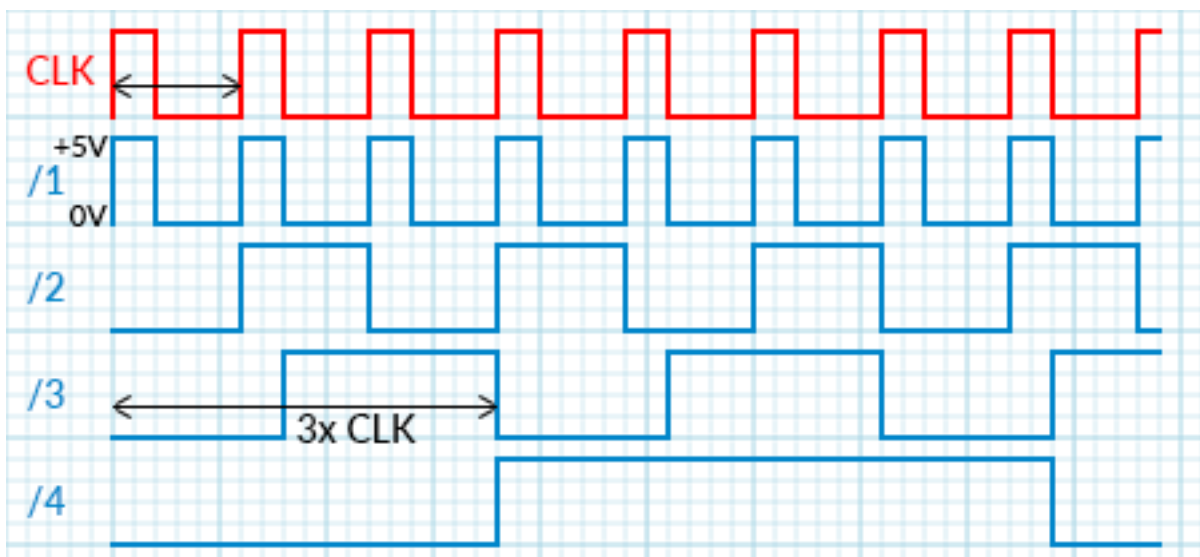

Up-beat counting for square source clock (CLK 33%) and outputs from /1 to /4 (gates).

As you'll can see, principle remain identical, but for /3, state durations are... 33% low, followed by 66% high-state. This technique permits to use any waveform source clock.

Now the same source clock (33%), but **down-beat counting**, combined with **gate** mode:

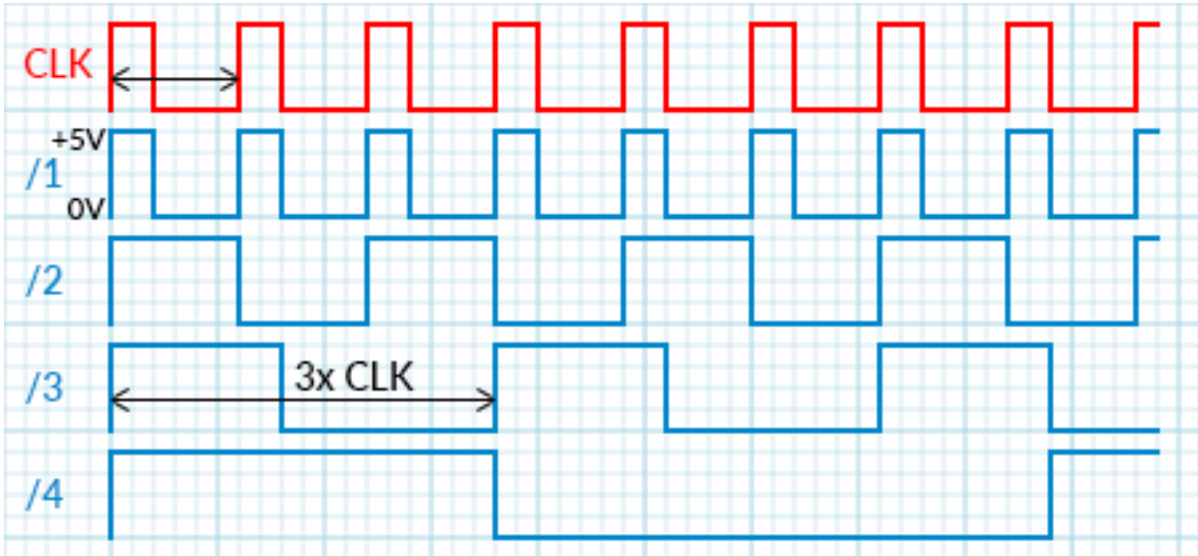

Down-beat counting for square source clock (CLK 33%) and outputs from /1 to /4 (gates).

MAX DIV

Max Div stands for **maximum divider amount**: used on "Manufacturer" dividers table, it's virtually defines the maximum possible divider for a given output jack (depending current table rotation). RKD module uses two "linked" jumpers, **J3** and **J4** (by default, both are On): By using two jumpers, this will offer four possible "Max Div" values:

J3	J4	Jumpers view	Max Div
ON	ON		8 (default)
ON	OFF		16
OFF	ON		32
OFF	OFF		64

However, other built-in dividers tables, such **Prime numbers**, **Perfect squares**, **Fibonacci sequence** and **Triplet & 16ths**, always use default "Max Div" 64 (whatever jumpers/switches setting), and **can't be changed**. "Prime numbers" dividers table sometimes can use "Max Div" 32 instead, regarding the greatest divider used by "J+8" output jack. These operations, for extra dividers tables only, are always done automatically by RKD module's firmware.

Like any other jumpers, you'll can change them anytime you want. However, new "Max Div" value becomes effective **on next CLK pulse** (rising edge, received by RKD module).

Concerning **RKD** expander module, it's more easy to select (and to read) the current "Max Div" setting, via two switches located into black serigraphy section of its plate.

Values indicated at middle (left and right sides) concern **same position for both switches**.
 By this way, both placed at left position means Max Div 64.
 Both placed at right position means Max Div 8 (it's the default setting).

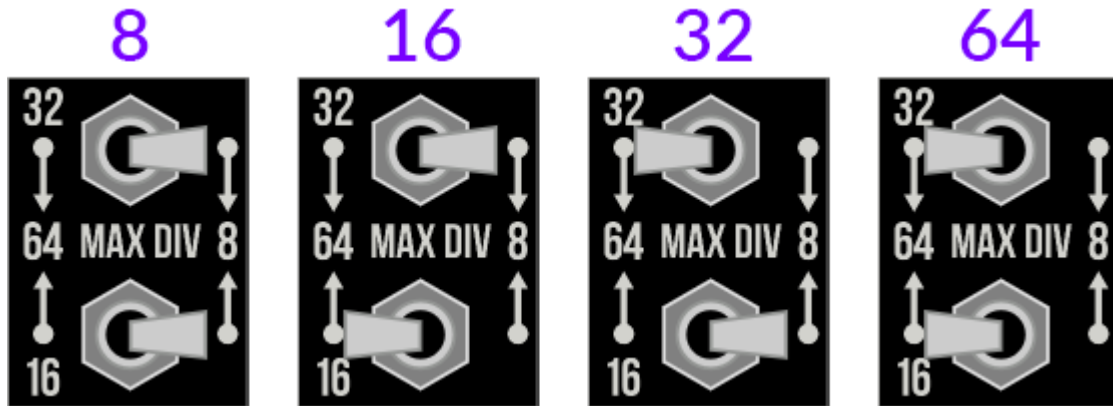

Possible "Max Div" settings, via switches on "BRK" panel.

SPREAD

Also dedicated to "Manufacturer" dividers table exclusively (and, by this way, ignored when extra dividers table is used, instead), when spread setting is set to "On", dividers are spread over all output ports, regarding the current "Max Div" setting.

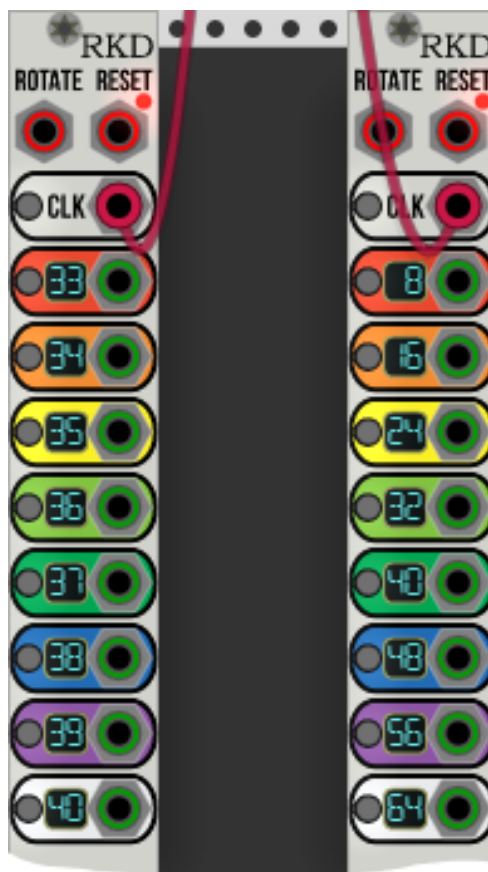

Spread off (left RKD) vs. on (right RKD), both "Manufacturer" dividers table, "Max Div" 64.

You can observe, on right RKD module (displays), used dividers are "spread" amongst the full "Max Div" (illustrated example in previous page shows Max Div set to 64).

Default (factory) is always set to **spread off** but can be changed to **spread on**, instead, either by installing (On) **J5 jumper** (RKD module), or by changing **SPREAD switch** to right position, from BRK expander panel ("ON" position):



Setting for spread on.

One of lovely feature will occur when "Max Div" is set to default 8 (jumpers J3 & J4 are on/installed, or both MAX DIV switches are set at right position from "BRK" panel), coupled with "Spread" set to On (jumper/switch position shown just above): in this case, all dividers become **musical-based**, like **triplets** (/3, /6, and /12) and **sixteenths** (/2, /4, /8, and /16). This particular situation implies the "Max Div" is automatically set as 16, instead of 8 (done by the module's firmware).

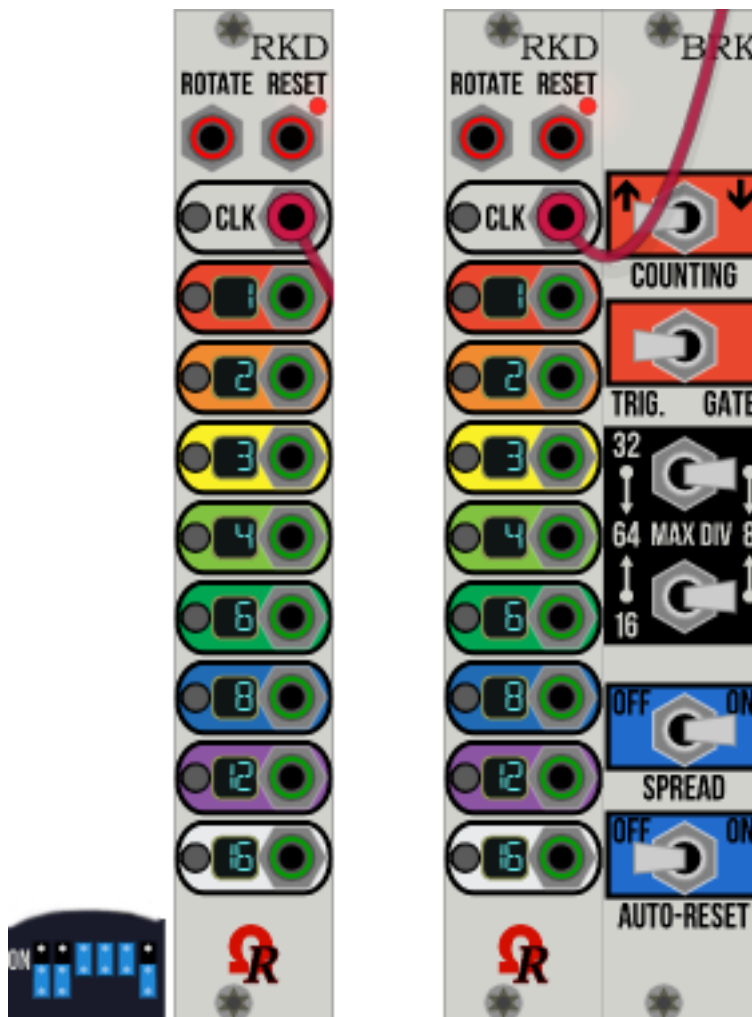

Spread on, together with "Max Div" set to 8, gives... musical-based dividers.

AUTO-RESET

(to be continued)...

This "User's Guide" remains...

